

# AUTOMATIC MACHINE TOOL ALIGNMENT ON ITS FOUNDATION

LUKAS HAVLIK<sup>1</sup>, LUKAS NOVOTNY<sup>2</sup>, PAVEL SOUCEK<sup>2</sup>

<sup>1</sup>Kovosvit MAS Machine Tools, Corp., Sezimovo Usti,  
Czech Republic

<sup>2</sup>CTU in Prague, Faculty of Mechanical Engineering, Institute of  
Production Machinery and Equipment | RCMT, Prague,  
Czech Republic

DOI: 10.17973/MMSJ.2024\_10\_2024039

e-mail: lhavlik@seznam.cz

## ABSTRACT

This article deals with the issue of the automatic setting of machines on their base. The focus is on machines with a self-supporting frame, freestanding, on more than three supports. The alignment uses the previously presented method of precise and repeatable machine placement on the foundation. As a result, the machine has the necessary parameters in terms of its geometry, and at the same time a defined weight distribution on the individual building elements is guaranteed. The paper presents a new method for automatic machine alignment using so-called "smart feet". Due to this, the process of machine alignment is clearly defined, repeatable and does not depend on the experience of the personnel performing the alignment. The presented algorithm makes it possible to automate the entire machine-setting process. The article includes the presentation of a machine placement on its base, which is used for testing and verification of the functionality of the alignment algorithm.

## KEYWORDS

machine tool, smart feet, levelling element, levelling adjustment, repeatable placement, alignment process

## 1 INTRODUCTION

The article deals with the possibility of automating a key process during the installation of a machine tool at a customer's site - the alignment of its internal geometry on its base.

The automated process of alignment of various objects is also addressed in specialised literature. Horizontal accuracy refers to a crucial factor that affects machining precision. Poor horizontal accuracy of a machine can lead to uneven vertical loading on its feet, causing deformation of the machine bed due to gravity. This resultant error affects the motion straightness and angular accuracy of the equipment, leading to sub-par machining flatness. Adjusting the horizontal accuracy of the equipment is achieved by adjusting the heights of the levelling bolts [Hsieh 2023]. Another paper describes an investigation of the automatic correction of errors in the rectilinear alignment of machine tools by means of an optical error detection system. Under the control of this system, a machine tool carriage travels as closely as possible within a true plane, irrespective of the inherent alignment errors of the machine tool, and this accuracy of the machine can be maintained throughout its life [Wong 1966]. Another study adopts a practical approach to establish the estimation and adjustment methods of the interface stiffness for the machine tool through finite element analysis (FEA). First, numerical and experimental modal analysis (FMA and EMA) are performed for each single subsystem of the

machine-tool structure. Then, the parameters obtained from EMA are used as the objective criterion function, and the FMA is conducted iteratively to solve the material Young's modulus and Poisson's ratio for each single subsystem structure. The initial value of the interface stiffness estimated by the deformation formula in the mechanics of the material is utilised as the initial condition for the iterative calculation in FMA. In the analysis, changes in the modal parameters are monitored. Interfaces that have a significant influence on the changes in the natural frequency of the whole machine tool are selected as the main object of modification. Then, the adjustment method proposed in this study is repeatedly applied to modify this interface stiffness. The results show that the stiffness of the footing interface plays the most important role that intensively affects the numerical analysis results of the modal parameter [Lin 2022]. In another case, the requirement of the vibration isolation system for ultra-precision machine tools was extremely stringent. However, most isolation systems currently cannot meet the requirement. Therefore, a new vibration isolation system to fulfil the strict vibration capability is required by ultra-precision machine tools [Zou 2014]. With the ever-increasing demands for higher and higher accuracy on modern CNC equipment, the manufacturing processes for machining and assembling the structural components are an increasingly important factor in establishing a geometrically correct machine tool. Specifically, the flatness, perpendicularity, parallelism, and straightness of the interface surfaces determine the basic accuracy of the machine tools. Exhibiting less geometric error allows other errors such as thermal growth, ball screw pitch error, and control error to be isolated and more easily corrected [Hansel 2014]. Another study developed level detection equipment that is used in CNC machine tools to determine the impact of levelling accuracy on rectilinear motion accuracy [Chen 2021]. The next article deals with the placement of machine tools on their foundations. Attention is paid to the alignment process for machines with a self-supporting frame that are free-standing on the foundation. The result is a statically indeterminate and nonrepeatable method of placement. This paper presents a new method that allows the machine to be aligned to the desired geometry. At the same time, it provides a defined weight distribution of the machine, on the individual levelling elements. The presented method uses smart feet to level the machine, followed by a unique transfer to standard feet. The method has been successfully verified in levelling a standard machine tool [Havlik 2022]. A large-scale crankshaft of an internal combustion engine is easy to bend and twist when clamped onto the grinding machine. The deviation of workpiece axis from its optimal machining axis has a significant influence on the machining accuracy of angle, eccentric throw, and diameter and contour of the heavy crankshaft in noncircular grinding. To reduce the consumption of manual labour and set-up time, an automatic alignment approach and apparatus are proposed and integrated into a non-circular grinder [Shen 2015]. Another paper describes a measurement method to accurately measure the tilt angle of a rotating machine for alignment or compensation using a dual-axis inclinometer. A model of the measurement of the rotating shaft tilt angle is established using a dual-axis inclinometer based on the designed mechanical structure. Subsequently, the calculation equation between the rotating shaft tilt angle and the outputs of the inclinometer axes is derived under the condition that the inclinometer axes are perpendicular to the rotating shaft [Luo 2015]. The electrohydraulic levelling system of the hydraulic press can realise the automatic levelling control function. To accurately remove the eccentric load force accurately, independent metering is designed. The quasi-static behaviour analysis of the

performance of the levelling cylinders' output forces is applied to the electrohydraulic levelling system with independent metering [Liu 2021]. Levelling is an important part of a machine tool installation process, because it significantly influences product quality, machine tool accuracy, and machine life. Conventional levelling procedures are performed by skilled engineers using levelling instruments, such as spirit levels or electronic levels. It is difficult to monitor the level of a machine tool, because an accurate levelling instrument is expensive and difficult to install. Therefore, a novel methodology for estimating the angle of inclination of a machine tool feed drive is proposed to overcome the difficulties of levelling. The proposed methodology utilises motor current measurements and a new mathematical model of the machine tool feed drive that considers the inclination [Jeong 2006]. A completely different area is dealt with in one study [Guo 2023], where the authors discuss the collection of safflower. In this experimental study, a new tilt-altitude levelling system was designed for a robot. The mobile platform was simplified as a four-point support, and an automatic levelling control system was designed based on the multisensor data collected by a multi-inclination sensor, a multi-pressure sensor, and a displacement sensor. The relationship between the inclination of the mobile platform and the displacement of the levelling mechanism was analysed by coordinate transformation. On this basis, an automatic levelling control system was designed.

The topic of automated machine alignment is a topical and practically solved one. However, none of the authors found applications described in the field of free-loading machine tools. The current situation can be summarised as follows. The main disadvantage at present is the ambiguity and nonrepeatability of the process of placing and aligning the machine tool on its foundation. The solution to this deficiency is to use a more sophisticated method, where the next input variable would be the actual force loading of the individual adjustment elements (feet) and also the measurement of their stroke. The motivation for the research described in this paper is to address these shortcomings.

This paper is structured as follows. First, a complex model of the machine with the machine mounted on adjustable (or smart) feet is described (Chapter 2), followed by the design and presentation of the automatic machine alignment process (Chapter 3). This is followed by an application to a specific machine model (Chapter 4). Finally, a summary of the whole work and its contributions is presented (Chapter 5).

## 2 COMPLEX MACHINE MODEL WITH SMART FEET

This chapter describes the creation of a complex machine model on smart feet. In the paper [Havlik 2022], a process was presented to uniquely define the alignment of a machine tool of a given type on its base. This is expressed in the first cell of the following diagram, see Fig. 1.

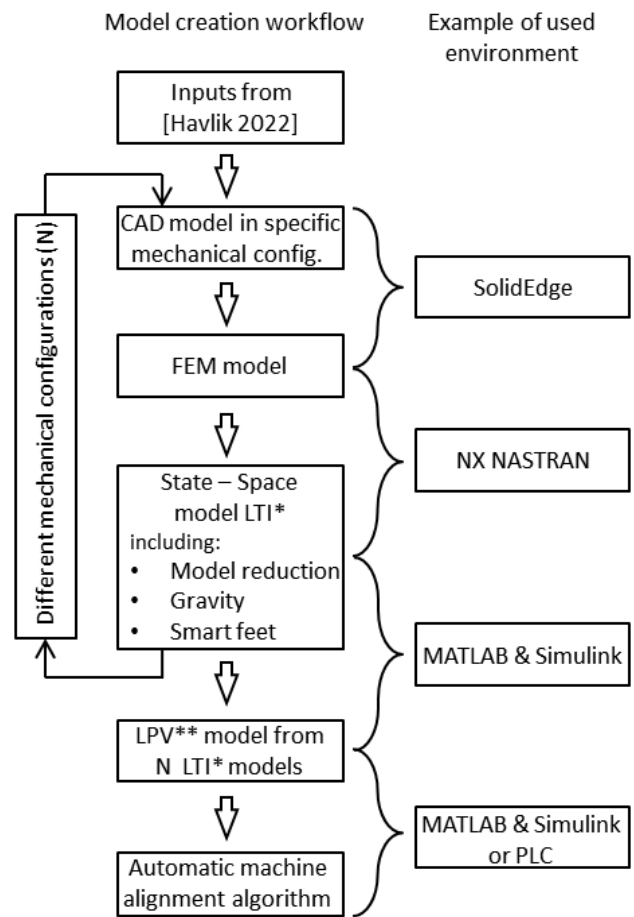

Figure 1. Generalised workflow (LTI\* stands for MATLAB: Linear Time-Invariant Model; LPV\*\* stands for MATLAB: Linear Parameter-Varying Model)

This directly uses the know-how already achieved in the previous paper [Havlik 2022]. The only difference is that now we want to do the alignment process automatically.

The means to develop the algorithm for automatic alignment will be a complex LPV model of the machine stored on smart feet - see Fig. 2. The inputs consist of the forces transmitted by these smart feet, the outputs consist of their positions (strokes) + the positions of points that are representative in terms of the machine geometry measurements (blue measuring cross, see Fig. 6 and Fig. 7).

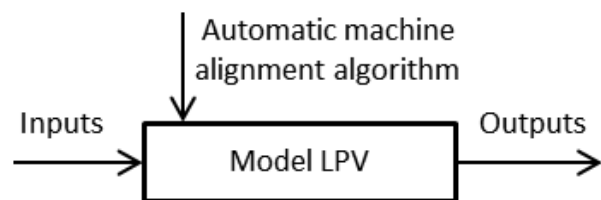

Figure 2. LPV model

## 3 DESIGN OF THE AUTOMATIC ALIGNMENT PROCESS

Block diagram of the whole automatic balancing process; see Fig. 3.

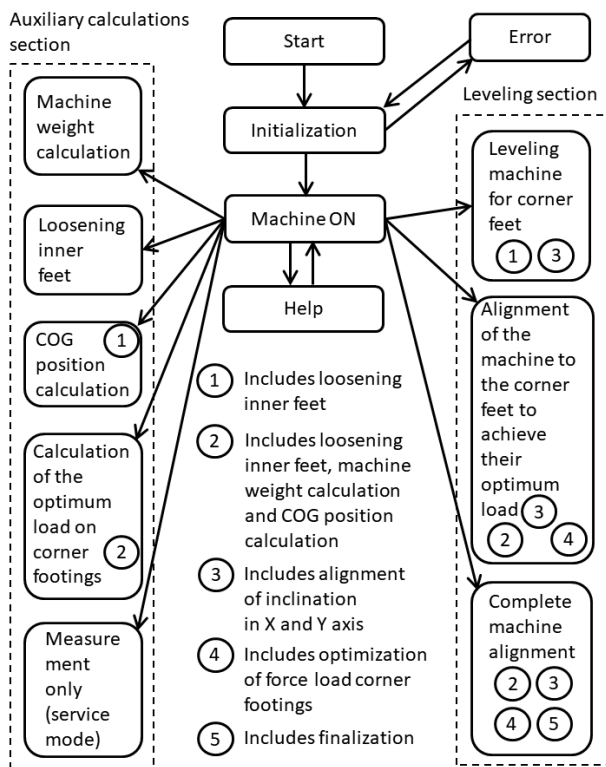

Figure 3. Block diagram of the whole balancing process

The aim is to design an algorithm for automatic machine alignment. The main tool for this design is a virtual model of the machine alignment on its base. In this model, the proposed algorithm can be debugged and its functionality tested. The algorithm is also designed considering the possibility of deployment on an industrial PLC.

In the block diagram (Fig. 3), an initialisation phase is introduced after the start block. During this phase, e.g. power circuits are switched on, pressure air is released, reference positions are found, etc. The program then enters the main junction. From there, either auxiliary calculations (left in Fig. 3) or individual balancing processes (right in Fig. 3) are started. Auxiliary calculations include weighing the machine, lightening the inner feet, calculating the position of the centre of gravity, calculating the optimum loading of the corner feet, and the service measurement mode. Alignment processes include alignment of the machine by using the corner feet, alignment of the machine by using the corner feet to achieve their optimum load, and complete alignment of the machine. It is also possible to have Help output from the main junction, e.g. with a description of the individual variables occurring in the blocks.

## 4 APPLICATION TO A SPECIFIC MACHINE MODEL

### 4.1 SELECTION OF MACHINE TOOL

The first step was, of course, to choose a representative machine tool that represents the given category of machine tool types. In this case, the MCV800 milling machine from Kovošvit MAS was chosen. This is the same type of machine that was the focus of most of the previous article [Havlik 2022]. The MCV800 is a three-axis vertical machining centre. The stroke of the main X-axis is 800 mm. The weight of the machine is about 3 000 kg.

### 4.2 CAD MODEL OF MACHINE TOOL

The following description refers to Fig. 1.

A detailed CAD model of the MCV800 frame exists. A necessary step for its use in FEM is to simplify its geometry. For example, it is used to suppress radii, threads, foundry bevels, and other unnecessary features. As this was an evolution of the presented methodology, the whole machine was regressed into a simple cube. Therefore, it is a very simple CAD geometry, and a simple FEM mesh. At the same time, this geometry allows for a relevant weight distribution to the individual footings. The plan dimensions of this object, the replacement machine, were identical to the plan dimensions of the bed of this machine. The height of the block was determined on an optimization calculation. For a schematic simplification of the geometry of the whole machine, see Fig. 4.

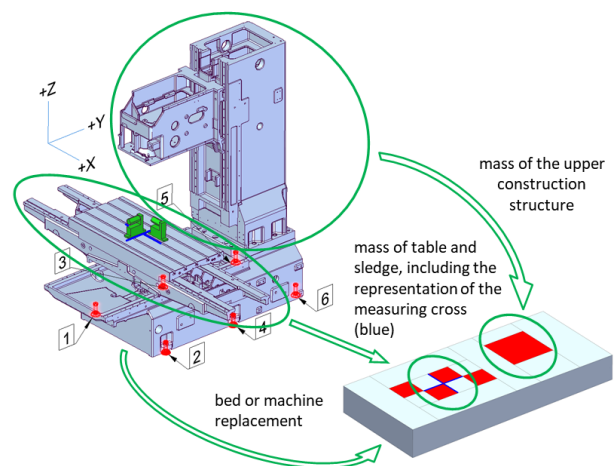

Figure 4. Simplifying the geometry of the MCV800

The CAD model of the replacement machine was prepared for subsequent meshing with a mapped network, for the application of material points (HB; i.e. points that are representative in terms of measuring the machine geometry), elastic elements and other necessary boundary conditions for the creation of the subsequent FEM model.

The material points represent the upper structural component of the machine (in particular the stand, spindle, spindle motor, and tool magazine), as well as the sled and table assembly. This is not a completely accurate reduction, of course. The HB of these masses does not lie in the top face of the block, but this is irrelevant in the development of this methodology. The nodes of the mass points of this latter assembly also serve as a so-called measuring cross (in blue in Fig. 5). This is used within the model to "measure" the vertical motion of these mass points. In real life, it is formed by two perpendicularly mounted spirit levels on the machine tool table, used in the alignment of the machine.

The underlying CAD model of the replacement bed, see Fig. 5, includes the legend and Table 1. It was designed to allow analysis in three discrete Y-axis positions (= LPV model), in both the two stroke positions of a given axis stroke, and in the middle of its stroke (i.e., at the nominal position).

The analysis is performed in the discrete positions of the Y-axis only. This axis is both much more heavily loaded than the X-axis (up to about 2.5 times) and much closer to the footings (i.e., to the source of possible imperfections). There is not as much "filtering" as in the case of the X-axis.

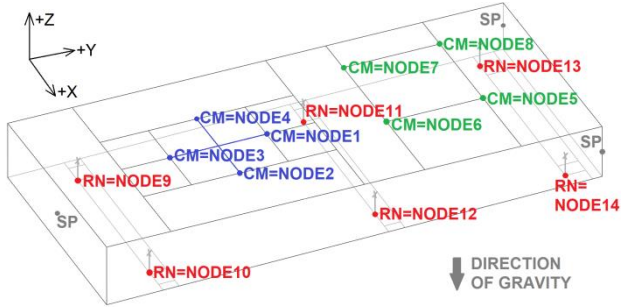

Figure 5. CAD model of the replacement bed, i.e. machine frame (in the centre of the Y-axis stroke)

- CM = concentrated mass
- SP = spring
- RN = restriction node
- node 1 + node 3 ... represents a physical spirit level (see Fig. 4), measuring the inclination in the Y-axis direction
- node 2 + node 4 ... represents a physical spirit level (see Fig. 4), measuring the inclination in the X-axis direction

Node number	Description of the node	Labels in MATLAB & Simulink
1	The first node of the leveller in the Y direction and also the HB of the sled and table group	L1
2	The first node of the leveller in the X direction and also the HB of the sled and table group	L2
3	Second node of the leveller in the Y direction and at the same time HB of the sled and table group	L3
4	Second node of the leveller in the X direction and at the same time HB of the sled and table group	L4
5	HB upper construction structures of the machine (stand, spindle, spindle motor, tray, etc.).	-
6		
7		
8		
9	Foot 1	P1
10	Foot 2	P2
11	Foot 3	P3
12	Foot 4	P4
13	Foot 5	P5
14	Foot 6	P6

Table 1. Description of individual nodes (refers to Fig. 5)

During the actual alignment of the machine geometry, the table is traversed in the Y-axis and is positioned in several discrete positions. The number of these positions during real setup

depends on the machine stroke in the respective axis. In the case of the MCV800 with a Y-axis stroke of 500 mm, there are five positions, 125 mm each. The emerging automatic machine alignment algorithm will operate (for simplicity) with only three positions: Y=0mm (HW limit at the operator), Y=250mm (centre of travel), and Y=500 mm (HW limit at the stand).

### 4.3 CREATION OF THE MKP MODEL

The CAD model of the replacement machine prepared in this way (according to Fig. 5, and also for the other two configurations) was subsequently output; see Fig. 6.

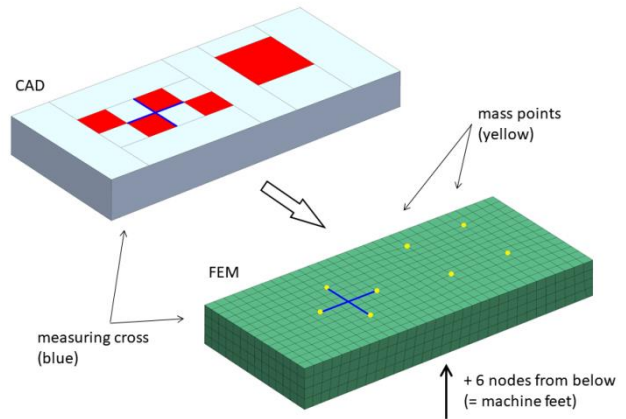

Figure 6. Conversion from CAD to FEA model of the replacement machine in the configuration according to Fig. 5

The three auxiliary springs (SP, see Fig. 5) are three-axial linear springs anchored to the ground, with a negligible stiffness of 1 N/mm. They are introduced for the numerical stability of the solver, since the surrogate model is designed as a free one, without standard constraints on motion at certain nodes (here typically at the footings).

The FEM calculation (i.e. the gain of the mass and stiffness matrix) was performed without load, and gravity is "activated" afterwards in Simulink.

### 4.4 CREATION OF STATE - SPACE MODEL

Although the FEM model of the machine was created as simply as possible (from the FEM point of view), it was still in an unacceptably high order (in terms of computational complexity of the HW used) from the Matlab point of view, respective to the creation of its state description. Static Guyan reduction was chosen as the model reduction method. The number of nodes was reduced from 2400 to 14 by the reduction (see Fig. 5, NODE1 to NODE14). The Guyan reduction is based on the reduction of the DOF matrices M and K, where only the loaded or otherwise representative coordinates are retained. The other coordinates are suppressed (reduced). Subsequently, a script was developed in Matlab to create a state-space model description of the machine. The script contains:

- Reading K and M matrices from text files
- Symmetrisation of matrix K (to reduce memory requirements, only the part of the matrix below the diagonal is exported from the solver)



- Definition of SlaveDofs (coordinates to be removed by Guyan reduction)
- The Guyan reduction itself
- Definition of the input force matrix L (machine foot) and the gravitational acceleration vector
- The definition of the matrix of measured coordinates P (measuring cross and machine foot)
- Generation of ABCD (state-space model) matrices

The validity of the created state-space model had to be verified later.

The correctness of the above procedure was verified by virtual "weighing" of the model in FEM and in Matlab, respective to Simulink. For this purpose, the model was placed on three feet. Footings 1, 4 and 5 were selected; see Fig. 4.

In the FEM, motion constraints were performed at the given footing nodes (see Fig. 5, NODES 9, 12 and 13) in the vertical Z direction. Furthermore, gravity was incorporated directly into the developed LTI model in a unique way. The method of model creation and inclusion of gravity can be seen in the relationships below:

$$M\ddot{x} + K\dot{x} = \vec{F} \quad / \cdot M^{-1} \text{ (from left)}$$

$$M^{-1} \cdot M\ddot{x} + M^{-1} \cdot K\dot{x} = M^{-1} \cdot \vec{F}$$

$$\ddot{x} = -M^{-1} \cdot K\dot{x} + M^{-1} \cdot \vec{F}$$

$$\dot{x} = \dot{x} \quad (\text{add } \dots 1=1)$$

$$\begin{bmatrix} \dot{x} \\ \ddot{x} \end{bmatrix} = \begin{bmatrix} 0 & I \\ -M^{-1}K & 0 \end{bmatrix} \begin{bmatrix} x \\ \dot{x} \end{bmatrix} + \begin{bmatrix} 0 & 0 \\ -M^{-1}L & \vec{G} \end{bmatrix} \begin{bmatrix} F \\ 1 \end{bmatrix}$$

1 ... "turning on" gravity

$$\vec{G} = \begin{bmatrix} 9,81 \\ 9,81 \\ \cdot \\ \cdot \\ \cdot \end{bmatrix}$$

**M, K, F, G** - matrices (vectors) of mass, stiffness, forces, and gravity

**I** - unit matrix

**L** - matrix of force inputs

**x** - general designation of the position coordinate

Introducing gravity into such an exported model was extremely difficult. The exported models from FEM contain inertia and stiffness, and damping can be added. But, it is usually done in an environment without gravity. This is useful for many applications (dynamics, control, etc.). But for an application where the Earth's gravitational field is a necessity, this poses a rather significant problem. No practicable method has been found to include gravity in models generated in this way. Therefore, a custom method of applying gravity via a constant gravitational acceleration acting on all the coordinates of the material was proposed.

In Simulink, a model was created to "weigh" the machine on three feet - see Fig. 7.

The core of this diagram is the ABCD (state-space) model just created, in a feedback loop. The input to this model is, in addition to gravity, the force exposure of the individual feet (feet 2, 3 and 6 are assigned the constant 0N), and the output of this model is the positions of the nodes of the libel and feet. Individual positions of the footings from the LTI model are subtracted from their desired positions (P1, P4, P5) in the differential component. The detected control deviation enters the sub PI controllers whose output is the (already mentioned) reaction forces in the individual footings. These are also monitored. Individual feedback circuits are replacements for height-adjustable feet. The PI controller in each branch can be viewed as a substitute for the stiffness of the footing. In the case of using the integration component of the controller, the footers are considered to be statically perfectly stiff. This case is satisfactory from the point of view of using the model to design the automatic alignment algorithm. In case of the need to include the real stiffness of the footings in the model, the controller would only have a proportional component.

The correctness of the proposed approach was subsequently verified, namely by static calculation in the NX NASTRAN environment using an unreduced model, see Fig. 8. It was further verified in the Simulink environment using the already reduced model - see Fig. 7 and Fig. 9, respectively. Both models show comparable results (in terms of numerical accuracy).

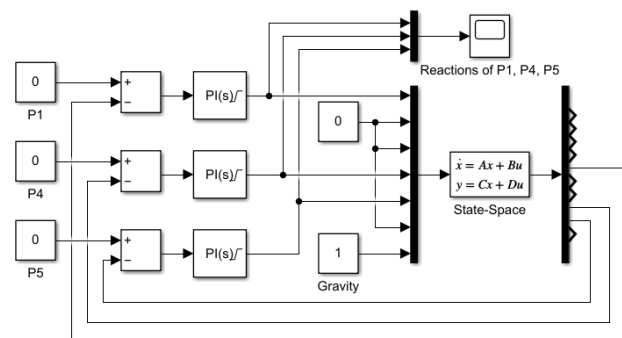

Figure 7. Schematic of weighing the machine model in Simulink

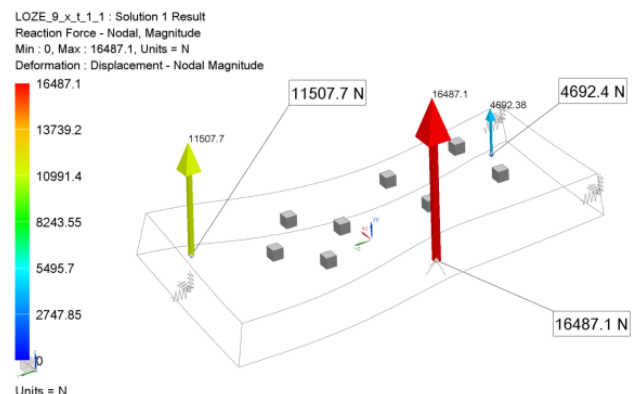

Figure 8. Weighing the machine model in FEA

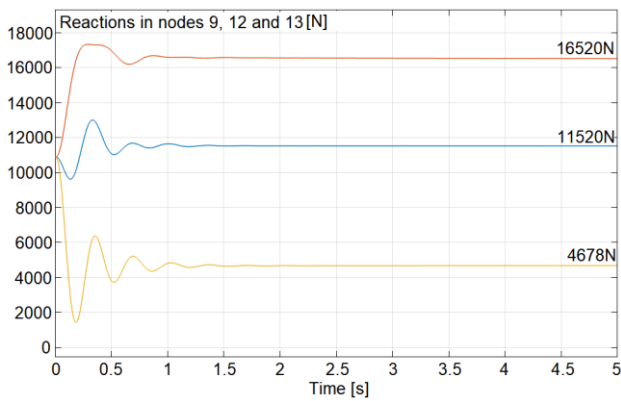

Figure 9. Weighing the machine model in Simulink

From the known total mass of the machine (3 300 kg) and the number of active feet (3), the initiation force (11 000 N) was determined. The transient behaviour (up to the end of the first second) is a function of the boundary conditions, mainly related to the gain of the CP and the time constant TN.

For the purpose of weighing the machine, a model of the smart foot was, of course, also developed - see Fig. 10 and Fig. 11.

Fig. 10 shows the actual and desired position of the foot.

Fig. 11 shows a schematic of the smart foot feedback control. The actual position of the foot is subtracted from its desired position on the differential component. The control deviation enters the controller, whose output is the reaction force in the given foot. This then enters the virtual machine model. Then it is output as the actual position of the foot.

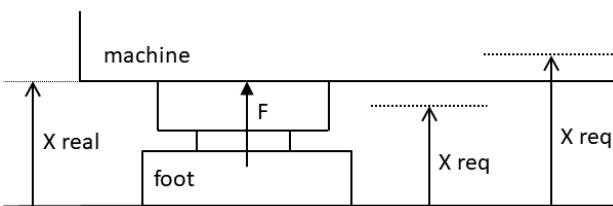

Figure 10. Schematic of the smart footing

An unanchored foot will not transmit the tensile component of the force. The saturation of this force can therefore vary from 0 to F max.

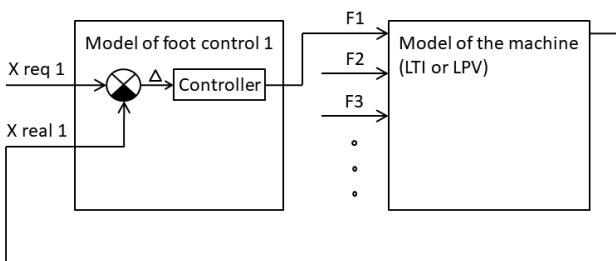

Figure 11. Smart foot control diagram

In steady state:

For  $X_{req} \geq X_{real} \dots \Delta \geq 0 \dots$  the model regulates

For  $X_{req} < X_{real} \dots \Delta < 0 \dots$  the unloaded foot has come off  
(model does not regulate)

#### 4.5 CREATING A MACHINE REPLACEMENT MODEL IN SIMULATION

The machine replacement model was de facto created by extending the machine weighing model (see Fig. 7). Gradually, all necessary boundary conditions and constraints were added to it, both for the actual functionality and then for the creation of the actual AAAM. All the footings were connected, and monitoring of the position of the libel and footing nodes was implemented. Furthermore, the possibility of unloading all the feet was treated, so that the model behaves correctly, as if it were loose on its foundation.

This model allows:

- Manual input of the desired positions of all feet (NODE9 to NODE14, in red in Fig. 5) [mm];
- Application of gravity [m/s<sup>2</sup>].

Based on the feedback, the model returns the following data:

- The actual positions of the foot nodes [mm];
- Relative changes in the positions of the footplate nodes (NODE1 to NODE4, in blue in Fig. 5) [mm];
- Possible deflection of some feet [0/1];
- Reactions on each footplate [N];
- Total reaction (to control machine weight) [N].

The requirement for the position of the footings is entered in the form of the absolute vertical coordinate of the required height for the footing.

All actual absolute positions of the footings and relative changes in the position of the libel nodes are entered or calculated in the vertical direction only, as are the reactions in the footings. This follows from the way the state-machine description was created (all X and Y coordinates were removed by static reduction).

Individual reactions are also still summed, which is an indicative verification of the correctness of the machine replacement model, relative to its known mass.

The model thus created is shown - see Fig. 12.

The machine replacement model was, of course, verified in FEM after it was built. The verification was carried out for different specifications of the desired positions of the individual feet, checking the actual position of the feet, their possible deflection and the reactions in them and the position of the libel nodes. In this way, a model of the alignment of essentially any machine of a given category can be obtained. Subsequently, it can be used for tests, respective to the design of the alignment algorithm. Realistically, it would not be very efficient to debug, for example, this algorithm on a physical machine.

Figure 12. Machine replacement model in Simulink

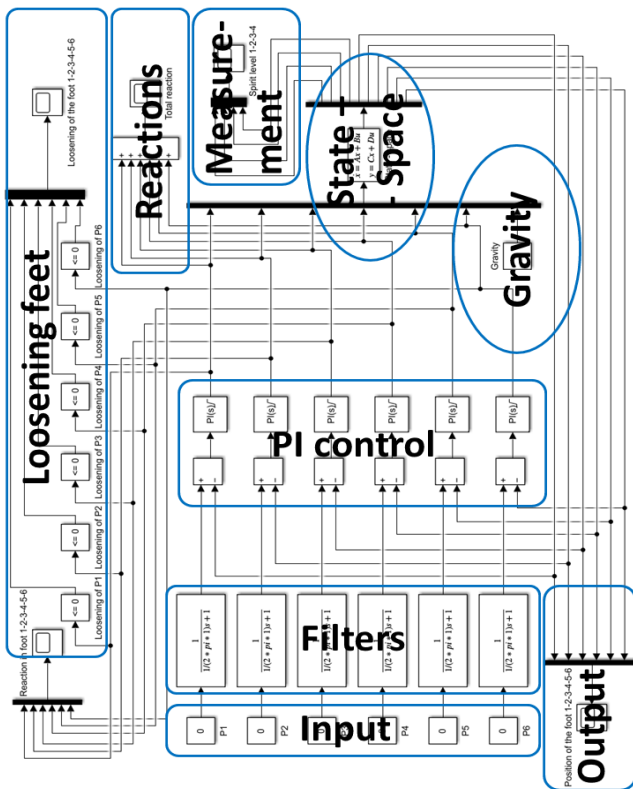

#### 4.6 CREATING AN ALGORITHM FOR AUTOMATIC MACHINE ALIGNMENT

The aim of the above algorithm is to create a generalisable methodology for the monitored process, which would eliminate the most significant identified shortcomings of the current method of alignment of machine tools on their foundations. More specifically, this methodology is based on a real process during the alignment of the machine during its installation at the customer's site, augmented by the real-time knowledge of the forces transmitted by each alignment element. The current standard machine alignment process (specified for vertical milling centres) was described in earlier research [Havlik 2022]. Therefore, only a point-by-point reminder of it is given here:

- Thermal equilibrium of the machine with the environment
- All feet set to the lowest initial height (during levelling, the machine will only be lifted, limiting the effect of foot lift hysteresis)
- Machine switched on, all axes in linkage and at the centre of their strokes
- Installation of two levellers on the table, in absolute mode, perpendicular to each other, in the direction of the X and Y axes
- Alignment of the machine (i.e. the two levellers) on the corner feet
- Activation of the inner feet together with the table and sledge traversing to several discrete Y-axis positions
- Minimising the absolute magnitude of both inclinations when building in these positions (iteratively, trial and error)

Compared to the conventional process, AAAM operates with smart feet. This provides information on current load and ejection. On the other hand, AAAM does not include the transfer of the balanced machine from the smart feet to the standard

feet, due to the irreplaceable contribution of the human operator in this transfer.

In the sample case, the whole AAAM is implemented in MATLAB & Simulink. The algorithm has three parts:

- Human-Machine Interface (HMI), implemented in Simulink - see Fig. 13
- An extended machine replacement model, also implemented in Simulink - see Fig. 14
- The actual state part of the algorithm, implemented in StateFlow - see Fig. 15

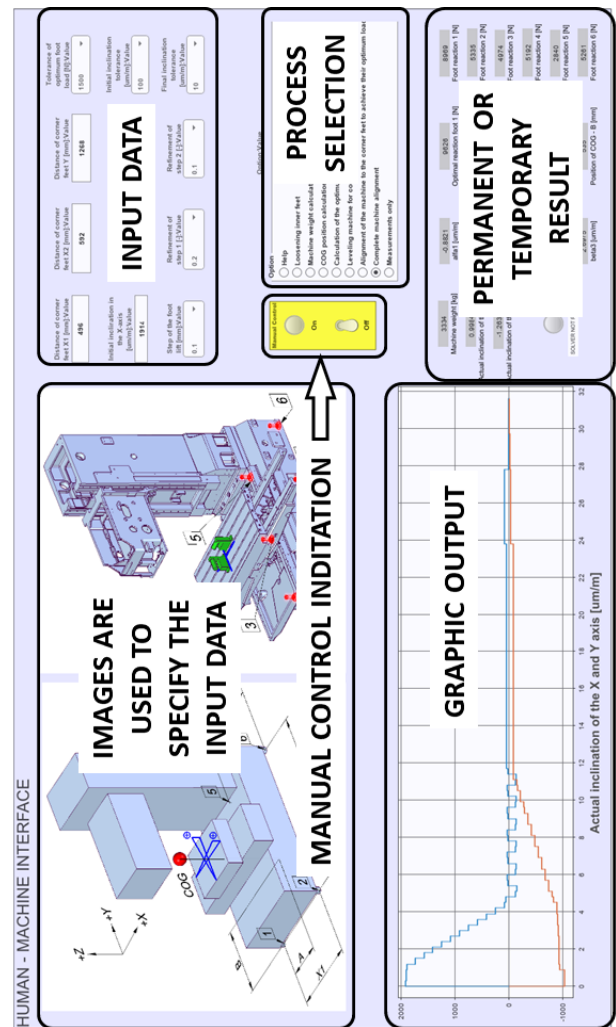

Figure 13. HMI interface (Simulink)

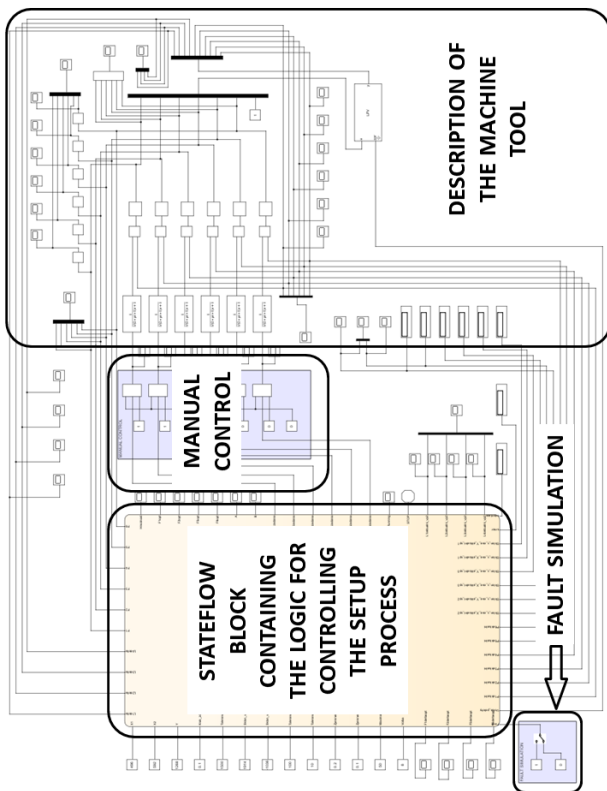

Figure 14. Extended machine replacement model (Simulink)

#### 4.7 HMI INTERFACE

In fact, the HMI panel is the only interface available and visible to the typical AAAM user. It contains both the ability to enter all necessary input parameters (either in the form of an exact notation or a selection from predefined values), the choice of process, i.e. what is actually to be calculated/executed, the display of all important calculated variables, an indication of the running solver, and, for testing purposes, the ability to switch to manual control.

The input parameters are in particular:

- Corner foot spacing (X1, X2 and Y dimensions, see Fig. 17) [mm];
- Initial X- and Y-axis inclinations [ $\mu\text{m}/\text{m}$ ];
- Foot lift step and its refinement [mm, -];
- Tolerance of inclination (initial and final) [ $\mu\text{m}/\text{m}$ ];
- Tolerance for optimal loading of corner feet [N];
- Maximum number of internal loop iterations [-];

The individual dimensions of the spacing of the corner feet, the numbering of the feet, the directions of the machine axes, the dimensions to the machine centre of gravity, the orientation (+/-) of the slopes in the X and Y axes, etc. are also shown on the machine diagram (picture) attached to the HMI panel for clarification.

All input parameters are described in the list when the Help process is invoked (see Fig. 16).

Calculated variables displayed include:

- Machine weight [kg];
- Machine centre of gravity position (dimensions A and B, see Fig. 17) [mm];
- Optimal load on the corner feet [N];
- Actual slope in the X and Y axes [ $\mu\text{m}/\text{m}$ ];
- Last recorded actual slopes of the X and Y axes when traversing each discrete Y-axis (alpha1 to beta3) [ $\mu\text{m}/\text{m}$ ];
- Current forces at all feet [N].

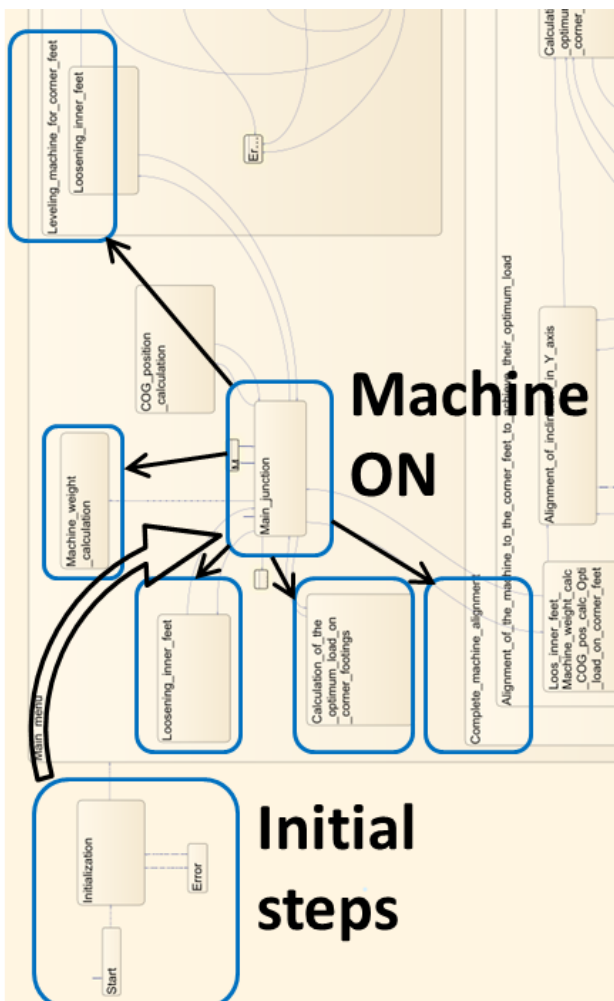

Figure 15. State part of the algorithm (StateFlow)

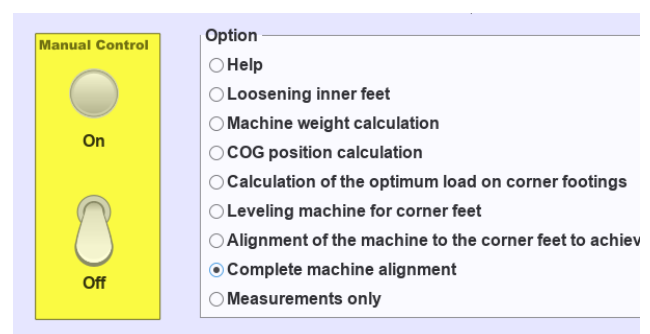
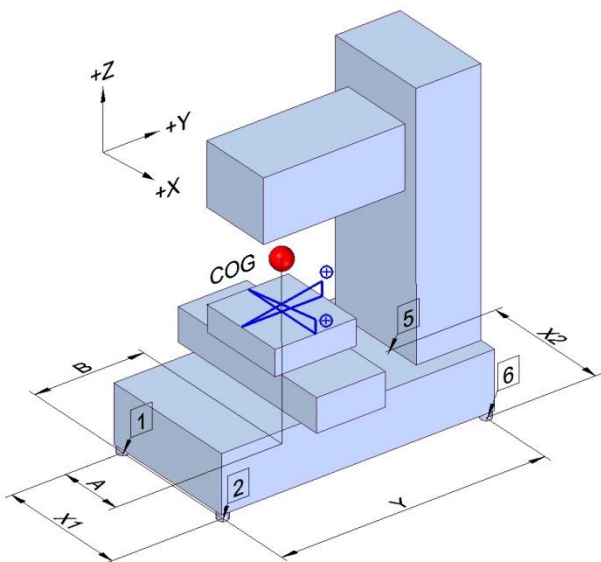

Figure 16. Indication of manual control (left) and selection of the desired process (right)





**Figure 17.** Orientation of inclinations, corner foot distances, and COG positions

#### 4.8 EXTENDED MACHINE REPLACEMENT MODEL

The previously introduced replacement machine was further extended to meet the needs of AAAM development. In particular, this includes:

- StateFlow Chart. This is the interface between this extended machine model in Simulink and the state part of the algorithm in StateFlow. The block has inputs and outputs around its perimeter that are used to control or monitor the entire AAAM. Some of the inputs are linked to the HMI.

The „State-Space“ block used in the machine replacement model is replaced here by the LPV (Linear Parameter - Varying) block. Based on a request (Option\_positions=...), it switches between the different state-space models of the machine, which belong to each discrete table position in the Y-axis. The workspace (.mat) used thus contains all three state-space models merged. It was created with the statement "sys = stack(1, SysfR\_vp1, SysfR\_vp2, SysfR\_vp3);", with the rule to call each position "sys.SamplingGrid = struct ('Option Positions', [1;2;3]);".

#### 4.9 STATE PART OF THE ALGORITHM

This part (i.e. the content of the StateFlow Chart block in Simulink) contains the actual logic control of the entire AAAM, in the form of a mathematical description of specific states and transitions between them. StateFlow can be imagined as an environment for creating interactive flowcharts. Code can be written natively only in StateFlow, or Matlab or Simulink can be called internally. It is possible to use conditions, cycles, delays between states, truth tables, and to operate with hierarchy, and to manage the way instructions are executed (e.g. serially or in parallel). The created StateFlow diagram can be compiled into a standard PLC language.

The state part of the algorithm is basically depicted in Fig. 3 and Fig. 15, respectively.

#### 4.10 EXAMPLE OF THE ALIGNMENT OF A CASE STUDY (AS A RIGID BODY) USING AAAM

The author dealt with the most complex option, the complete alignment of the machine.

It was an important demonstration that the machine behaves like a rigid body under certain conditions. One of the conditions is that the foundation underneath will be tilted within small limits. The proof was made by a series of tests with AAVS, in Manual Control with the "Measurement Only" option. Small limits are generally considered to be inclinations at which the machine, as such, does not change its position significantly with respect to the gravity directive. A frame value of 1000  $\mu\text{m}/\text{m}$  can be considered a small inclination, which corresponds to a deviation of the gravity directive from the vertical of approx. 0.06°. At the same time, this value of inclination is sufficient for the use of AAVS, where after the alignment of the machine on the corner feet (or after geometric and force optimisation), i.e. before the program enters the "Finalisation" summary block, both inclinations are typically on the order of 10  $\mu\text{m}/\text{m}$ .

The tests were carried out by changing the positions of all the footings (i.e., one was determined as a reference), based on the geometric conditions of the mutual distances of each footing that were read in CAD. The monitored quantities were the transmitted forces through all the footings. When changing the position (stroke) of each footing within small limits, the distribution of their forces did not change.

For the model case of alignment of the MCV800 machine using AAAM, the following input data were entered:

- Distance of corner feet X1 = 496 mm
- Corner foot distance X2 = 592 mm
- Corner foot distance Y = 1268 mm
- Tolerance for optimum footing load = 1500 N
- Initial inclination in X-axis = 1914  $\mu\text{m}/\text{m}$
- Initial inclination in Y-axis = -1036  $\mu\text{m}/\text{m}$
- Maximum number of inner loop iterations = 50
- Original inclination tolerance = 100  $\mu\text{m}/\text{m}$
- Final tolerance of inclination = 10  $\mu\text{m}/\text{m}$
- Foot lift step = 0.1 mm
- Refinement of step 1 = 0.2
- Refinement of step 2 = 0.1

Result of the whole alignment process; see Fig. 18.

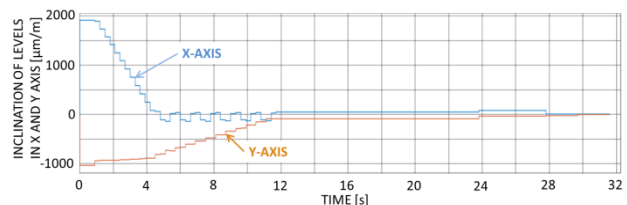

**Figure 18.** Result of the case study of the balancing algorithm

Total alignment time: 31.5 s

Residual inclination in X-axis: 0.998  $\mu\text{m}/\text{m}$

Residual inclination in Y axis: -1.264  $\mu\text{m}/\text{m}$

In connection with this article, two other papers were written.

The Bachelor's thesis by Antonin Jedlicka, entitled "Design of an electrohydraulic actuator with low stroke", deals with the design of an actuator for smart machine tool feet. The drive for each

stop consists of a hydraulic cylinder with pressure measurement, a noncontact piston extension sensor and an associated pressure fluid source.

The Master's thesis of the author Bc. Ales Jiranek, entitled "Preparation of PLC for automatic setting of machine tools on the base", deals with the creation of a PLC code for the automatic setting of bulk machine tools up to 20 tons. Among other things, it deals with the control of the alignment on the Beckhoff industrial platform.

Both papers make use of the findings presented in this paper and expand the possibilities of their real application in practice.

## 5 CONCLUSION

In the introduction (Chapter 1), the article was devoted to a contemporary analysis of the methods of setting and aligning machines and other devices based on them, with a focus on the automation of this process. Subsequently, the paper dealt with the description of a complex machine model with storage on adjustable (i.e. smart) feet, which was used as a means for the development and testing of AAAM (Chapter 2). The next chapter (Chapter 3) dealt with the design of this automatic alignment process, based on the MATLAB & Simulink platform. The penultimate chapter was a case study demonstration of the automatic alignment process (Chapter 4). Finally, a summary of the whole work and its contributions was presented (Chapter 5).

Thus, a virtual machine model was created on the base. This was subsequently modified and extended with various (i.e. more sophisticated) elements. Smart feet were added, including the possibility of unbending them. Furthermore, the model was reduced by static reduction (Guyan). Subsequently, gravity was activated in Simulink, the possibility of analysing the machine behaviour in multiple mechanical configurations was added, etc.

The output is therefore a model of the machine on smart feet, which allows the machine to be positioned in a controlled way and at the same time to measure the values of the forces transmitted by these smart feet.

The described AAAM, in effect, views the machine as a rigid body. This is despite the fact that the base on which it is placed can tilt freely within small limits.

AAAM consists of 3 interconnected parts. A Human Machine Interface (HMI) where the user can enter various input parameters and control the actual setting process. Furthermore, there is a description of a complex machine model equipped with the above-mentioned sophisticated elements, as well as an actual state description. In it, a description of individual states and transitions between them is solved in the form of mathematical notation.

Thus, it can be concluded that a new, unique and automated process of setting up and aligning a machine tool on its base has been developed and verified. According to the simulations carried out, a reduction in angular imperfections from thousands of  $\mu\text{m}/\text{m}$  to single digits of  $\mu\text{m}/\text{m}$  was achieved.

The presented algorithm has real potential for deployment in industrial practice. The main advantage lies in the unambiguity and static certainty of the machine setting and alignment process on its base. Moreover, the algorithm itself and its state part can be compiled into a common PLC language.

## ACKNOWLEDGMENTS

This work was supported by the Grant Agency of the Czech Technical University in Prague, grant no. SGS22/159/OHK2/3T/12.

## REFERENCES

- [Guo 2023] Guo, Hui, et al. Design and Test of a Levelling System for a Mobile Safflower Picking Platform. *Applied Sciences*, 2023, Vol. 13, No. 7, p. 4465.
- [Hansel 2014] Hansel, Adam, et al. Improving CNC machine tool geometric precision using manufacturing process analysis techniques. *Procedia CIRP*, 2014, Vol. 14, pp 263-268.
- [Havlik 2022] Havlik, Lukas, et al. Method for precise and repeatable machine tool adjustment on foundation. *MM Science Journal*, 2022, No. 10, pp 5801-5811.
- [Hsieh 2023] Hsieh, Tung-Hsien, et al. Horizontal Accuracy Monitoring System for Precision Machinery. Eurasia Conference on IOT, *Communication and Engineering*, IEEE, 2023, pp 202-207.
- [Chen 2021] Chen, Shao-Hsien, et al. Level Detection Equipment for Measuring the Influence of Different Leveling Accuracies on Linear Error. *Journal of Sensors*, 2021, pp 1-15.
- [Jedlicka 2023] Antonin. Navrh elektrohydraulickeho pohonu s nizkym zdvihem (in Czech). Bachelor's thesis.
- [Jiranek 2023] Ales. Priprava PLC pro automaticke ustaveni obrabecih stroje na zaklad (in Czech). Master's thesis.
- [Lin 2022] Lin, Shen-Yung, et al. Estimation and Adjustment of Interface Stiffnesses for Machine-Tool. *Applied Sciences*, 2022, Vol. 12, No. 23, p. 12384.
- [Liu 2021] Liu, Kailei, et al. Angle and force hybrid control method for electrohydraulic leveling system with independent metering. *Mathematical Problems in Engineering*, 2021, pp 1-13.
- [Luo 2015] Luo, Jun, et al. Rotating shaft tilt angle measurement using an inclinometer. *Measurement Science Review*, 2015, Vol. 15, No. 5, p. 236.
- [Jeong 2006] Jeong, Young Hun, et al. Estimation of machine tool feed drive inclination from current measurements and a mathematical model. *International Journal of Machine Tools and Manufacture*, 2006, Vol. 46, No. 12-13, pp 1343-1349.
- [Shen 2015] Shen, Nanyan, et al. Precise alignment method of the large-scale crankshaft during non-circular grinding. *The International Journal of Advanced Manufacturing Technology*, 2015, Vol. 80, pp 921-930.
- [Wong 1966] Wong, G. S. K., et al. Automatic correction of alignment errors in machine tools. *International Journal of Machine Tool Design and Research*, 1966, Vol. 6, pp 171-197.
- [Zou 2014] Zou, XiCong, et al. Study on the auto-leveling adjustment vibration isolation system for the ultra-precision machine tool. *Advanced Optical Manufacturing Technologies*, SPIE, 2014, pp 606-612.